

FERODOTM

YOU'RE IN CONTROL

www.ferodoracing.com

Kart Attack

2012-2013



 **FEDERAL
MOGUL**

Introduction:

This catalogue details the Ferodo Kart Attack range of brake pads for karting applications. It has been designed for use by both distributors and racing teams and contains full application data, product shape illustrations as well as material compound data.

Part Number/Suffixes

All part numbers in the range section of this catalogue contain a suffix. This identifies the material compound available for that part number as follows:

KA/P = Organic Racing KS/ST = Sintered racing

Introduzione:

Il catalogo Ferodo Kart Attack è uno strumento di lavoro che permette alla rete di distribuzione Ferodo ed ai teams di scegliere correttamente la figura della pastiglia e la miscela per ottenere la miglior efficienza dell'impianto frenante utilizzato.

Significato dei suffissi:

Il suffisso nella parte finale del numero di codice viene utilizzato per identificare la miscela:

KA/P = Organic Racing KS/ST = Sintered racing

Introduction:

Ce catalogue détaille la gamme des plaquettes de frein Ferodo Kart Attack pour applications karting. Conçu pour une utilisation aisée à la fois des distributeurs et des Equipes de Course, ce catalogue contient une partie applications et une partie illustrations.

Références/Suffixes:

Tous les codes dans la section gamme de ce catalogue contiennent un suffixe. Ce suffixe indique la qualité disponible pour chacune des références. Les matériaux disponibles avec les suffixes appropriés sont les suivants:

KA/P = Organic Racing KS/ST = Sintered racing

Einführung:

In diesem Katalog ist das komplette Ferodo Bremsbelag-Programm für Kart Anwendungen aufgeführt. Der Katalog wurde für Händler und Renn-Teams konzipiert und enthält sämtliche Anwendungsdaten, Produktabbildungen und Materialdaten.

Teile-Nummern/Suffix:

Alle Teile-Nummern in diesem Katalog enthalten einen Zusatz. Durch diesen läßt sich das für diese Teile-Nr. verfügbare Material wie folgt identifizieren:

KA/P = Organic Racing KS/ST = Sintered racing

Introducción:

Este catálogo detalla la gama de pastillas de freno Ferodo Kart Attack, para aplicaciones en kart. Diseñado para facilitar su uso a Distribuidores y Equipos de Competición, el catálogo contiene los datos de aplicación/compuesto y la ilustración de las siluetas de las pastillas.

Referencia/Sufijos:

Todas las referencias en la parte gama de ésta catálogo, presentan un sufijo. Este sufijo identifica el material o compuesto disponible para cada referencia en concreto. Los compuestos disponibles y los sufijos respectivos, son los siguientes:

KA/P = Organic Racing KS/ST = Sintered racing

Ferodo kart pads reference	Adaptable to:
FDB3KA	Birel (rear)
FDB207ST	Alpha (Rear) Brembo calipers Sodikart (rear)
FRP213P	Kelgate
FDB342P	Anderson Big Bowman English Kart Kelgate Solo (rear) Stratos
FRP405KS	Brembo Calipers Track Magic (front)
FDB2038KA	Alpha MBA Righetti Ridolfi Top Kart (rear) Wilson Zip Kart
FDB2046KA	Biesse (rear) Birel Europa GoKart Haase Sodikart
FDB2051KA	Swiss Hutless (rear)
FDB2069KA	Birel (rear)
FDB2070KA	Arc Piranha (rear) Righetti Ridolfi Venom
FDB2072KA	CRG (rear)
FDB2074ST	Brembo Calipers
FDB2076KA	Haase (front)
FDB2077KA	Tony Kart Trulli (front)
FDB2078KA	Tony Kart Trulli (rear)
FDB2081KS	Brembo calipers Grimeca calipers Track magic (rear)
FDB2088KA	CRG Kombi Kart PCR Techno (rear)
FDB2089KA	Alpha (rear) Mach 1 Techno (rear) Kelgate
FDB2091P	
FDB2093KA	CRG (rear) Top Kart (front) Wilson (front)
FDB2151KS	CRG 2000 (front&rear)
FDB2152KA	CRG 1999 (front)
FDB2160KA	Tony Kart (rear)
FDB3000KA	CRG (rear)
FDB3001KA	Intrepid (Rear)
FDB3002KA	Tony Kart (Front & Rear)



FDB3	W 55.7mm x H 53 mm x D 14.5mm	FDB207	W 40mm x H 56.4mm x D 7mm	FRP213	W 59.5mm x H 54.4mm x D 10.2mm
-------------	-------------------------------	---------------	---------------------------	---------------	--------------------------------

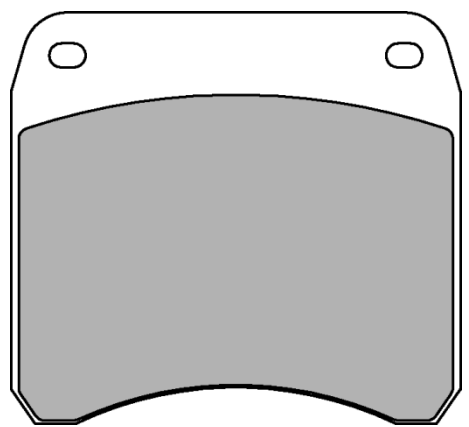
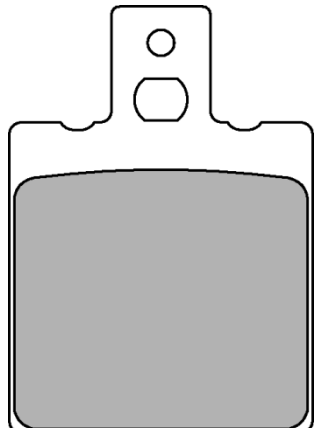
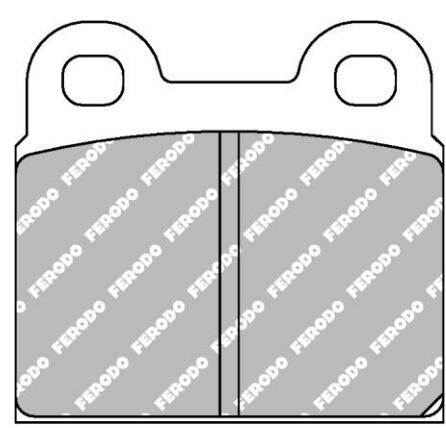

FDB342	W 59.5mm x H 51.6mm x D 10.2mm	FRP405	W 36.1mm x H 45.1mm x D 6mm
---------------	--------------------------------	---------------	-----------------------------

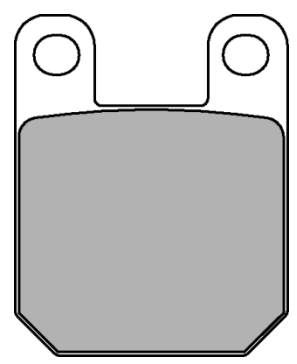
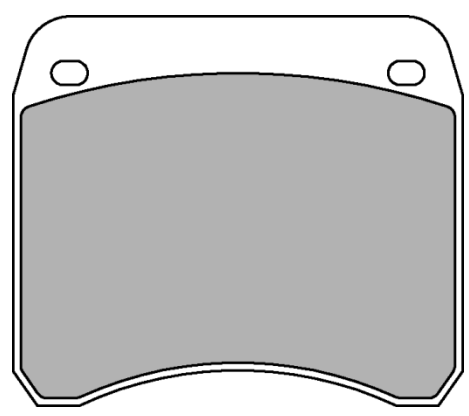

FDB2038	W 98.8mm x H 38.8mm x D 13.6mm
----------------	--------------------------------

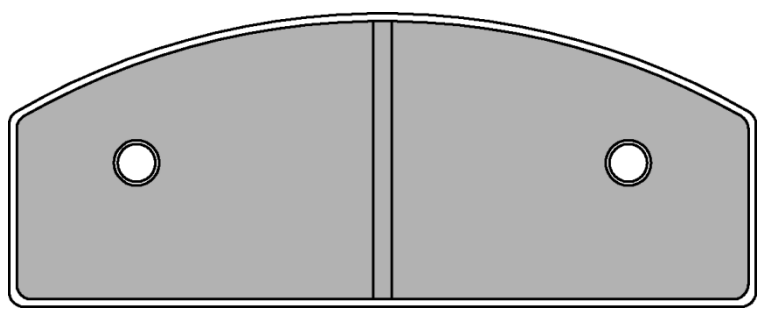



FDB2046

W 90.2mm x H 55.1mm x D 16mm

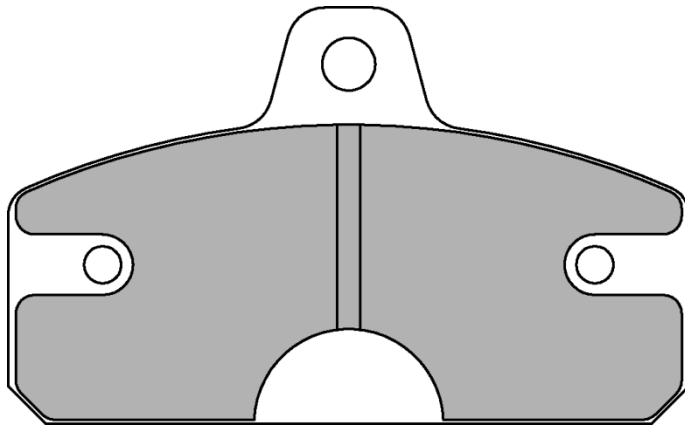

FDB2051

W 93.7mm x H 36.7mm x D 13.6mm

FDB2069

W 90.2mm x H 55.1mm x D 11.5mm

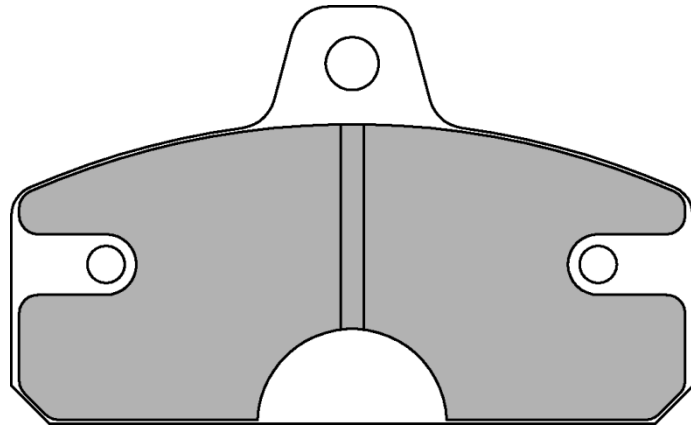
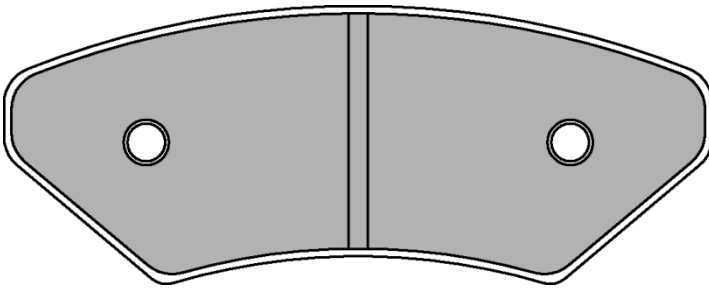

FDB2070

W 90.2mm x H 55.1mm x D 13mm

FDB2072

W 84.4mm x H 51.5mm x D 15mm

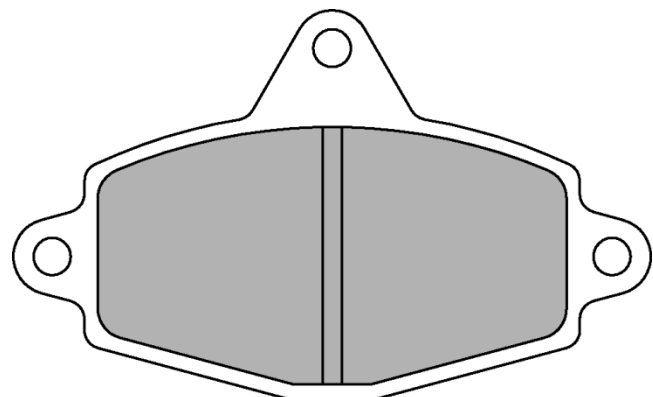
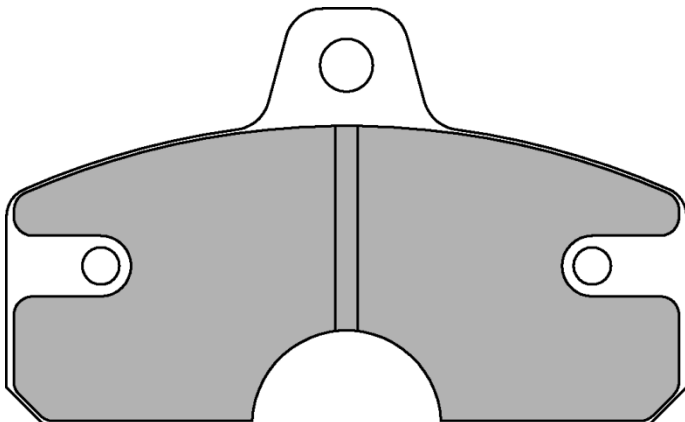



FDB 2074

W 51mm x H54mm x D 7.5mm

FDB2076

W 67.4mm x H 26.6mm x D 6.8mm

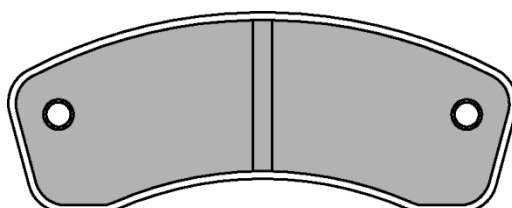
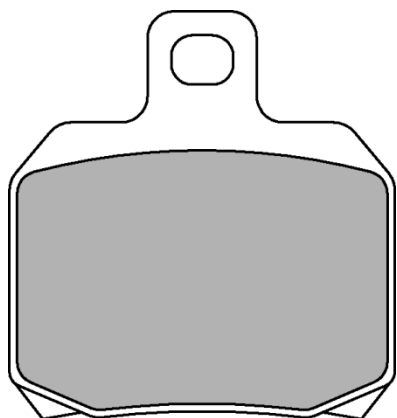

FDB2077

W 57.1mm x H 44.5mm x D 10mm

FDB2078

W 71.4mm x H 53.9mm x D 16mm

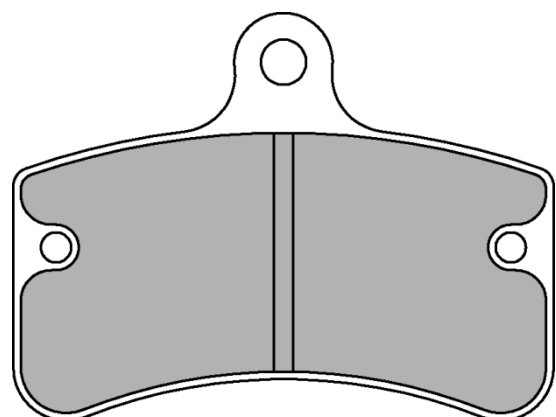
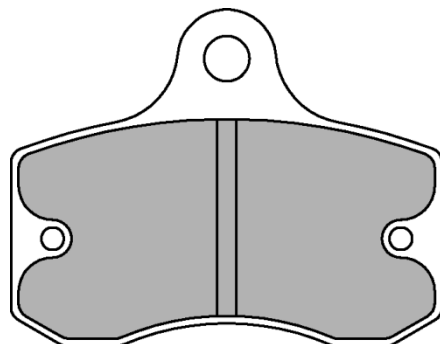

FDB2081

W 39.8mm x H 56.6mm x D 8mm

FDB2088

W 98.8mm x H 38.8mm x D 17mm

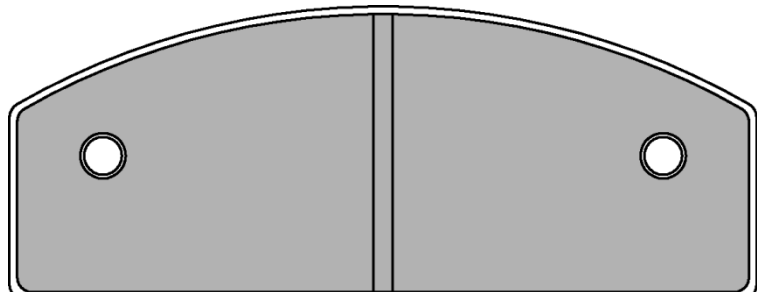
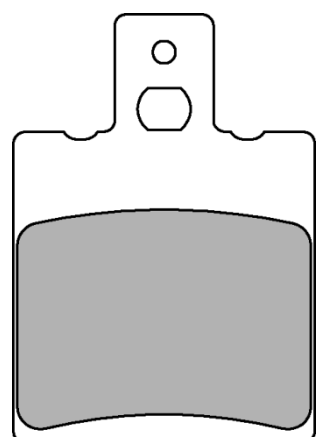



FDB2089

W 98.8mm x H 38.8mm x D 17.3mm

FDB2091

W 79.7mm x H 43.9mm x D 10.3mm

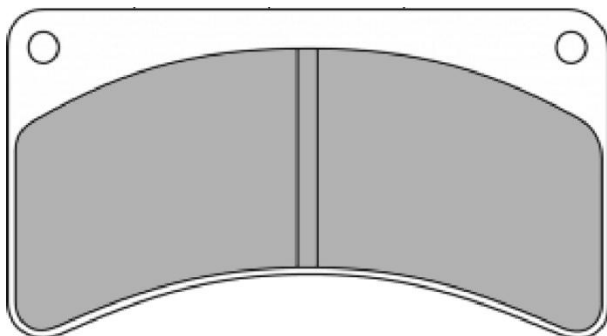
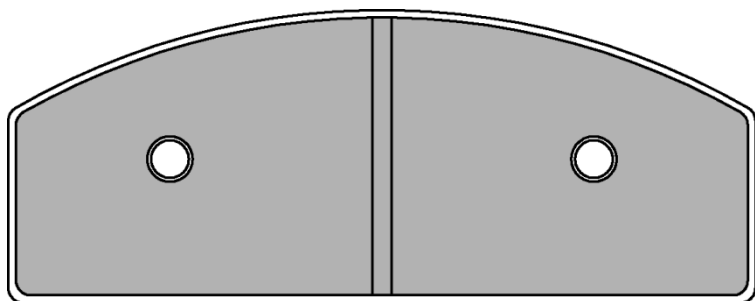

FDB2093

W 84.4mm x H 50.6mm x D 10mm

FDB2152

W 82.2mm x H 46.9mm x D 10mm

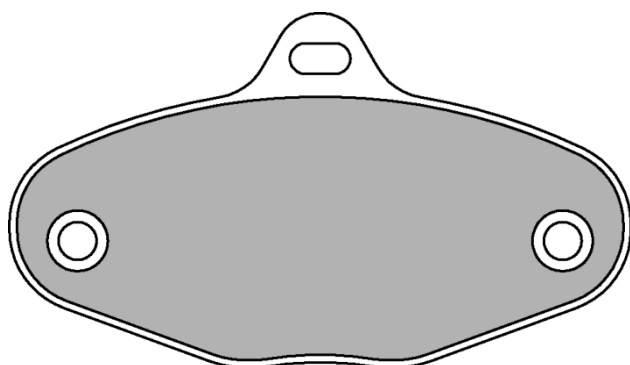
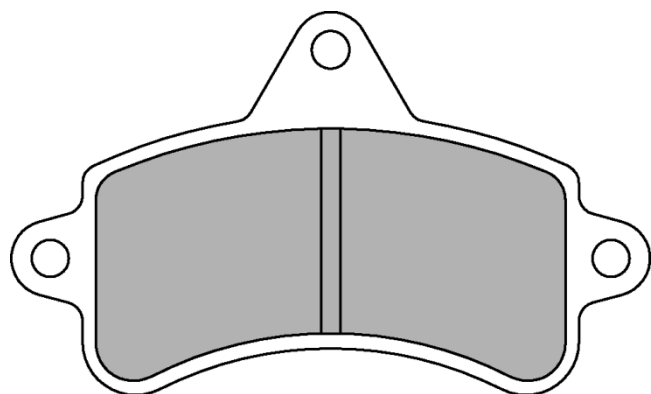

FDB2151

38mm x H 49.1mm x D 8.5mm

FDB2160

W 44.1mm x H 59.2mm x D 9mm

FDB3000

W 58mm x H 50.5mm x D 11.8mm

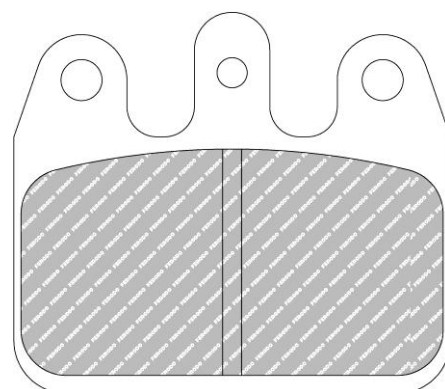
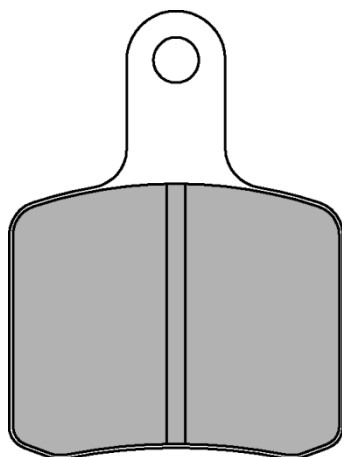
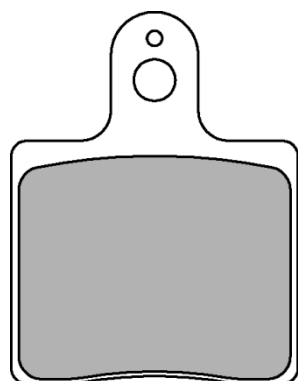



FDB3001

W 80mm x H 46.1mm x D 13mm

FDB3002

W 44.1mm x H 57.4mm x D 9mm

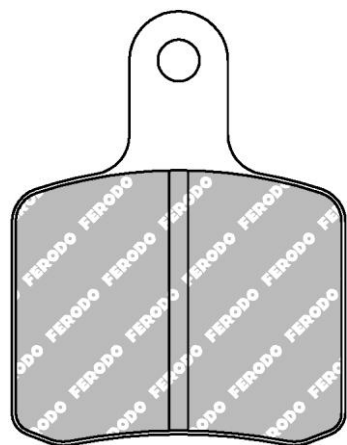
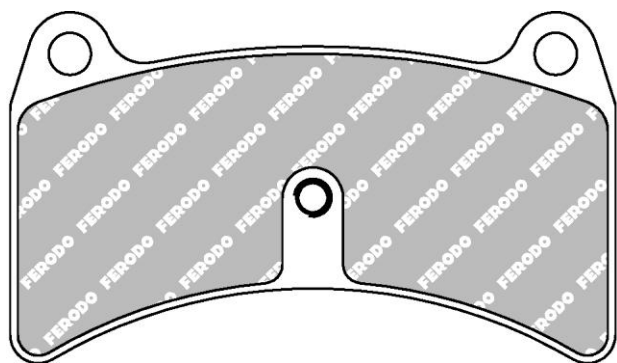

Characteristic \ Compound	Bite	Modulation	Release	Compatibility with Various Disc types	Pad Life
Sintered	✓		✓		✓
Organic		✓	✓	✓	

Compound Selection Guide:

Sintered Compounds (KS & ST): These sintered metal compounds demonstrate high bite and a high friction coefficient under all conditions, with excellent life.

Organic Compounds (KA & P): These organic compounds offer slightly reduced friction coefficient when compared to sintered metal compounds, but offer improved modulation for superior “feel.” They also offer better compatibility against a greater range of disc types.

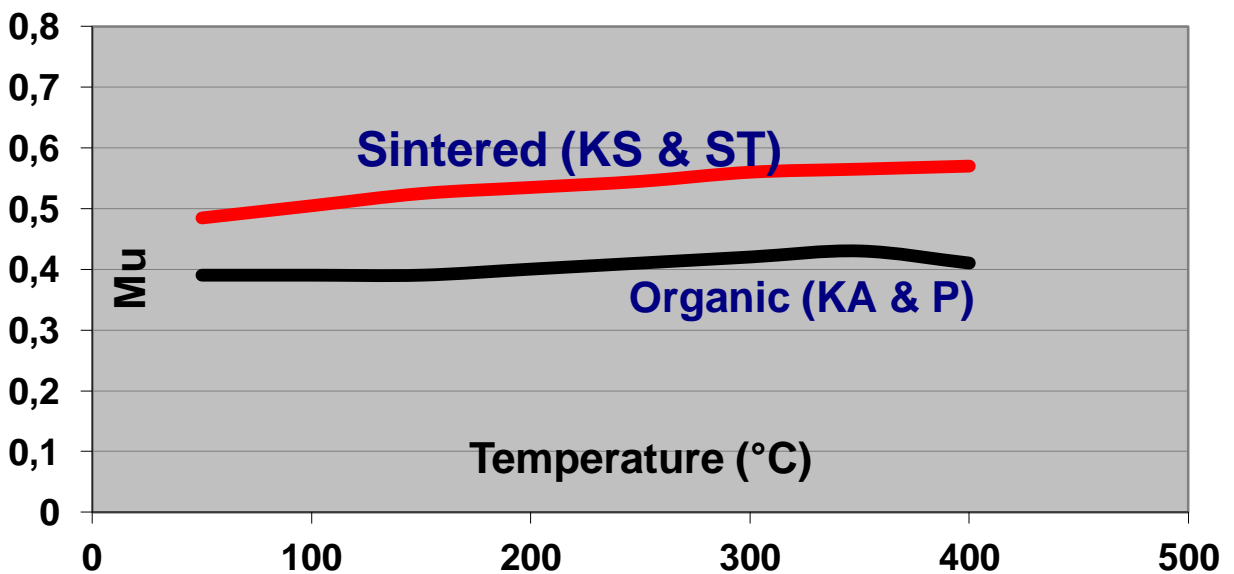

FEDERAL MOGUL ITALY Srl
Racing & Motorcycle Division
 Corso Inghilterra, 2
 I-12084 Mondovì (CN)
 Italy
 Tel. 0039 0174 560511
 Fax 0039 0174 552248